



SOLAR PUMPS

**NORWIK**<sup>®</sup>

## 1. DC SOLAR PUMP

2" DC SCREW/IMPELLER SOLAR PUMP	01
3" 4"DC SS SCREW SOLAR PUMP	02
3" DC PLASTIC IMPELLER SOLAR PUMP	03
3" DC SS IMPELLER SOLAR PUMP	04
4" DC PLASTIC IMPELLER SOLAR PUMP	05
4" 6" BRUSHLESS SS IMPELLER SOLAR PUMP	07
NKQB DC SOLAR SURFACE PUMP	09
NKGJ/PSZ DC SOLAR SURFACE PUMP	10
NKHF DC SOLAR SURFACE PUMP	11
NKSU DC SOLAR SURFACE PUMP	13
NKP DC SOLAR SWIMMING POOL PUMP	14
NKG DC SOLAR SUBMERSIBLE PUMP	15

## 2. AC/DC SOLAR PUMP

3" AC/DC PLASTIC IMPELLER SOLAR PUMP	17
3" AC/DC SS IMPELLER SOLAR PUMP	18
4" AC/DC PLASTIC IMPELLER SOLAR PUMP	19
4" 6" AC/DC SS IMPELLER SOLAR PUMP	21
NKGJ-H/PZSU-H AC/DC SOLAR SURFACE PUMP	23
NKHF-H AC/DC SOLAR SURFACE PUMP	24
NKP-H AC/DC SOLAR SWIMMING POOL PUMP	25
NKG-H AC/DC SOLAR SUBMERSIBLE PUMP	26

## 1. DC SOLAR PUMP

- ▷ Permanent magnet DC brushless motor, efficiency improved by 20~30%.
- ▷ Longer use life than normal electrical AC pump motor.
- ▷ High efficiency intelligent MPPT controller makes pump start and stop working automatically.
- ▷ Overload protection, over current protection, underload protection, under voltage protection, reverse connect protection, thermal protection, well shortage water protection, soft start.
- ▷ Controller LED screen displays voltage, current, power, speed RPM, adjusting speed, error code.
- ▷ Controller waterproofing grade IP54.
- ▷ Ambient temperature: -15~70 °C.

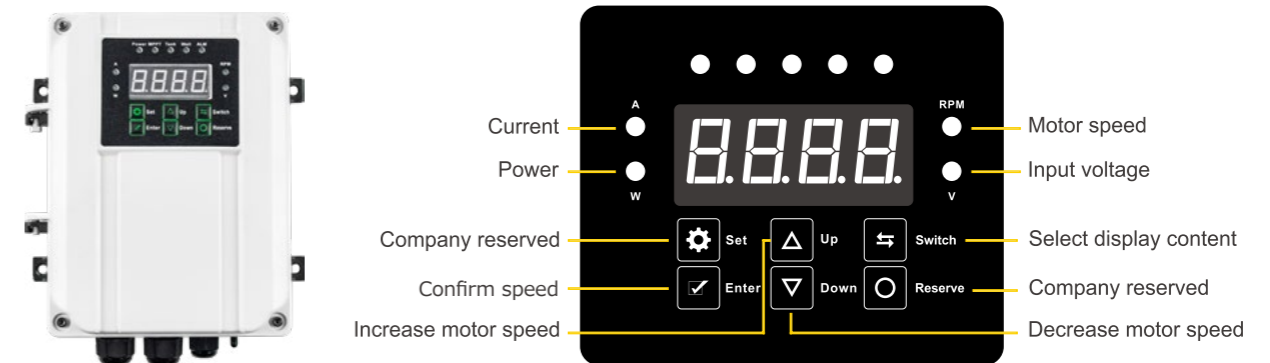

### SOLAR PANELS CONNECTION FOR DC SOLAR PUMP

DC Pump	DC Input Voltage VOC (V)	Solar Panels Connection	
12V 200W	11~55		12V Battery Solar panel: 150Wp*2PCS
24V 180/250/300W	11~55		250Wp*1PC 330Wp*1PC
48V 400W	45~100		250Wp*2PCS 300Wp*2PCS
72V 600W	60~150		250Wp*3PCS 300Wp*3PCS
96V 750W	60~200		250Wp*4PCS 300Wp*3PCS
144V 1100W	90~340		250Wp*6PCS 300Wp*5PCS
72V 1100W	60~150		250Wp*6PCS 300Wp*6PCS
192V 1500W	90~430		250Wp*8PCS 300Wp*7PCS
96V 1500W	60~200		250Wp*8PCS 300Wp*8PCS
280V 2200W	100~490		250Wp*12PCS 300Wp*10PCS
385V 3000W	280~780		250Wp*16PCS 300Wp*13PCS

## 2" DC SCREW/IMPELLER SOLAR PUMP

### MATERIAL OF PUMP

- ▷ Outlet/connection fitting: brass/stainless steel
- ▷ Cylinder: iron
- ▷ Pump body: 201 stainless steel
- ▷ Pump cable: 2M
- ▷ Oil cooling
- ▷ MPPT function controller
- ▷ 1 year warranty

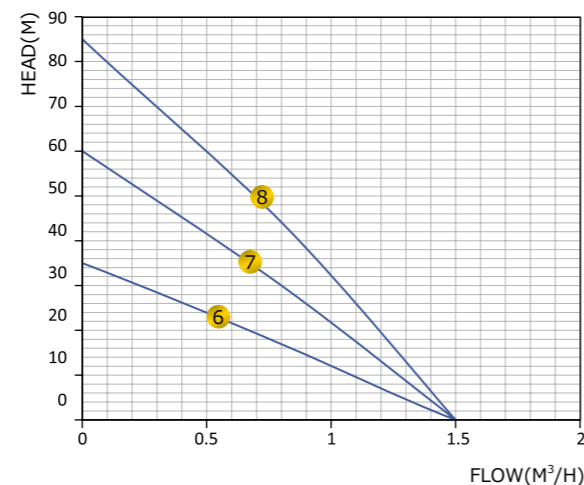
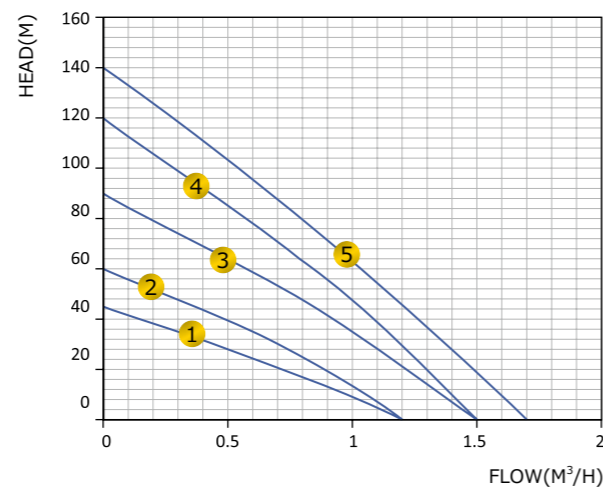
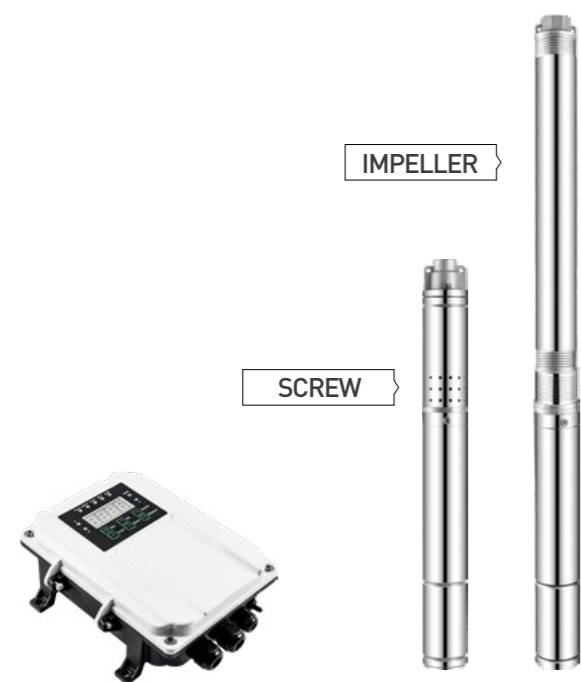

ITEM NO.	DC VOLTAGE (V)	BEST INPUT VOLTAGE VOC (V)	POWER (W)	MAX FLOW (M³/H)	MAX HEAD (M)	OUTLET (INCH)
1	24	11~55	180	1.2	45	0.75"
2	24	11~55	250	1.2	60	0.75"
3	48	45~100	400	1.5	90	0.75"
4	72	60~150	600	1.5	120	0.75"
5	96	60~200	750	1.7	140	0.75"
6	24	11~55	250	1.5	35	0.75"
7	48	45~100	400	1.5	60	0.75"
8	72	60~150	600	1.5	85	0.75"

## 3" 4" DC SS SCREW SOLAR PUMP

### MATERIAL OF PUMP

- ▷ Outlet/connection fitting: 201 stainless steel
- ▷ Cylinder: iron
- ▷ Pump body: 201 stainless steel
- ▷ Screw: steel + rubber
- ▷ Pump cable: 2M
- ▷ Oil cooling
- ▷ MPPT function controller
- ▷ 1 year warranty

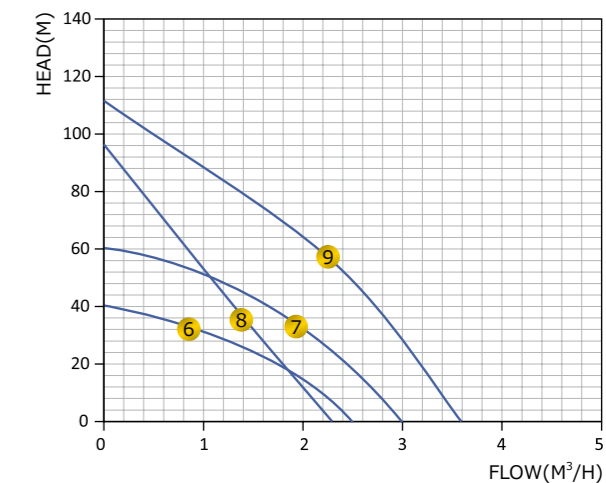
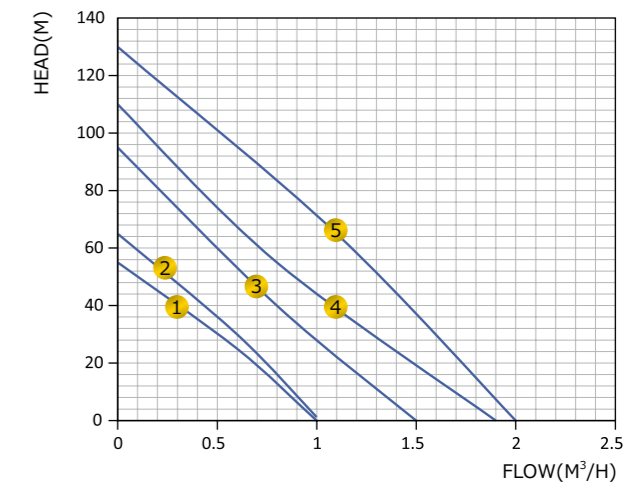

ITEM NO.	DC VOLTAGE (V)	BEST INPUT VOLTAGE VOC (V)	POWER (W)	MAX FLOW (M³/H)	MAX HEAD (M)	OUTLET (INCH)
1	24	11~55	180	1.0	55	0.75"
2	24	11~55	250	1.2	65	0.75"
3	48	45~100	400	1.5	95	0.75"
4	72	60~150	600	1.9	110	0.75"
5	96	60~200	750	2.0	130	0.75"
6	24	11~55	250	2.5	40	1"
7	48	45~100	400	3.0	60	1"
8	72	60~150	600	2.3	95	1"
9	96	60~200	750	3.6	110	1"

## 3" DC PLASTIC IMPELLER SOLAR PUMP

### MATERIAL OF PUMP

- ▷ Outlet/connection fitting: brass/stainless steel
- ▷ Cylinder: iron
- ▷ Pump body: 201 stainless steel
- ▷ Pump cable: 2M
- ▷ Oil cooling
- ▷ MPPT function controller
- ▷ 1 year warranty

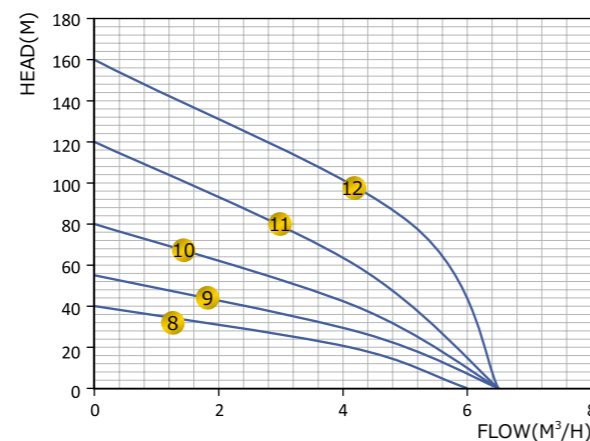
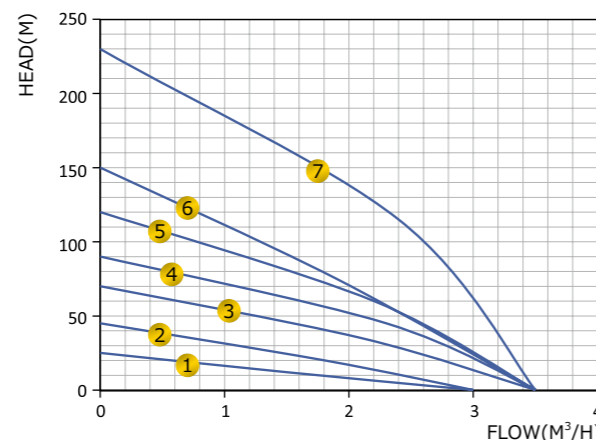

## 3" DC SS IMPELLER SOLAR PUMP

### MATERIAL OF PUMP

- ▷ Outlet/connection fitting: 304 stainless steel
- ▷ Cylinder: iron
- ▷ Pump body: stainless steel
- ▷ Impeller: 304 stainless steel
- ▷ Pump cable: 2M
- ▷ Oil cooling
- ▷ MPPT function controller
- ▷ 1 year warranty

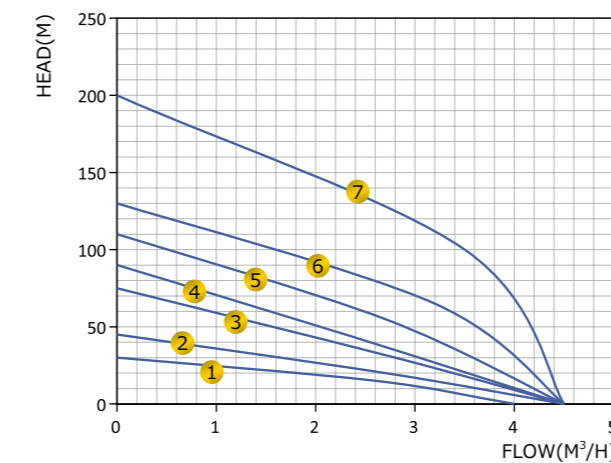

ITEM NO.	DC VOLTAGE (V)	BEST INPUT VOLTAGE VOC (V)	POWER (W)	MAX FLOW (M³/H)	MAX HEAD (M)	OUTLET (INCH)
1	24	11~55	300	3.0	30	1"
2	48	45~100	400	3.0	45	1"
3	72	60~150	600	3.5	70	1"
4	96	60~200	750	3.5	90	1"
5	144	90~340	1100	3.5	120	1"
6	192	90~430	1500	3.5	150	1"
7	280	100~490	2200	3.5	230	1"
8	72	60~150	600	6.0	40	1"
9	96	60~200	750	6.5	55	1"
10	144	90~340	1100	6.5	80	1"
11	192	90~430	1500	6.5	120	1"
12	280	100~490	2200	6.5	160	1"

ITEM NO.	DC VOLTAGE (V)	BEST INPUT VOLTAGE VOC (V)	POWER (W)	MAX FLOW (M³/H)	MAX HEAD (M)	OUTLET (INCH)
1	24	11~55	300	4.0	30	1.25"
2	48	45~100	400	4.5	45	1.25"
3	72	60~150	600	4.5	75	1.25"
4	96	60~200	750	4.5	90	1.25"
5	144	90~340	1100	4.5	110	1.25"
6	192	90~430	1500	4.5	130	1.25"
7	280	100~490	2200	4.5	200	1.25"

## 4" DC PLASTIC IMPELLER SOLAR PUMP

### MATERIAL OF PUMP

- ▷ Outlet/connection fitting:stainless steel
- ▷ Cylinder:iron
- ▷ Pump body:stainless steel
- ▷ Impeller:plastic impeller
- ▷ Pump cable:2M
- ▷ Oil cooling
- ▷ MPPT function controller
- ▷ 1 year warranty

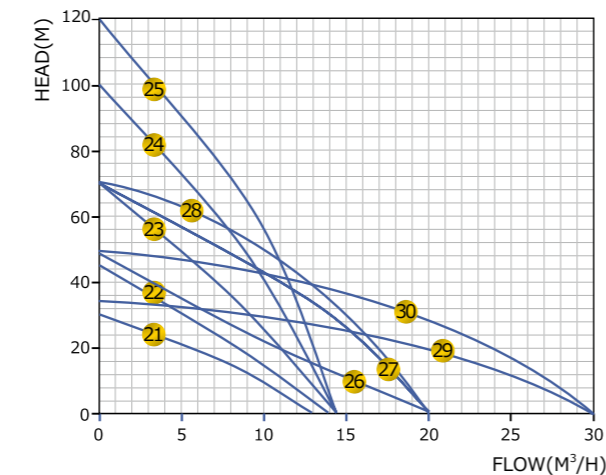
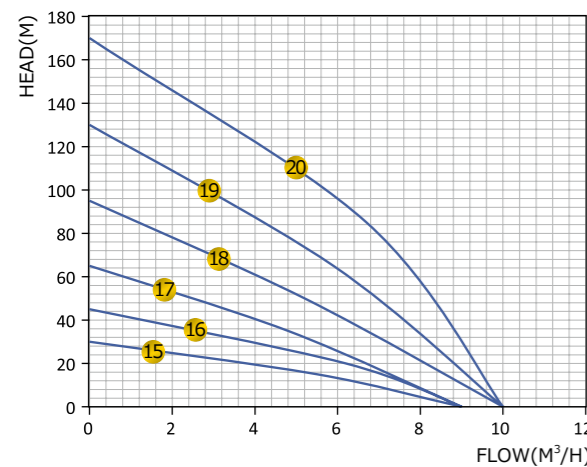
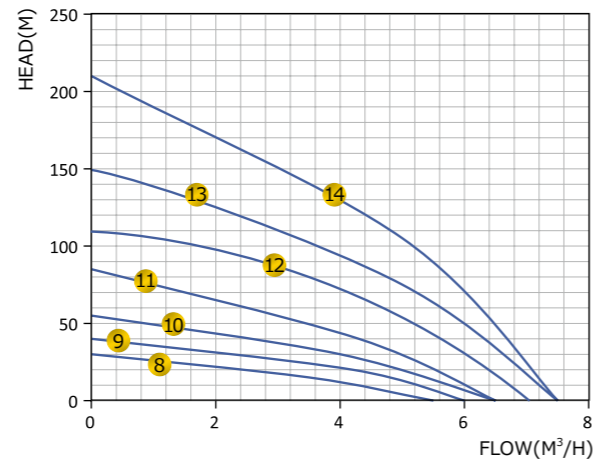
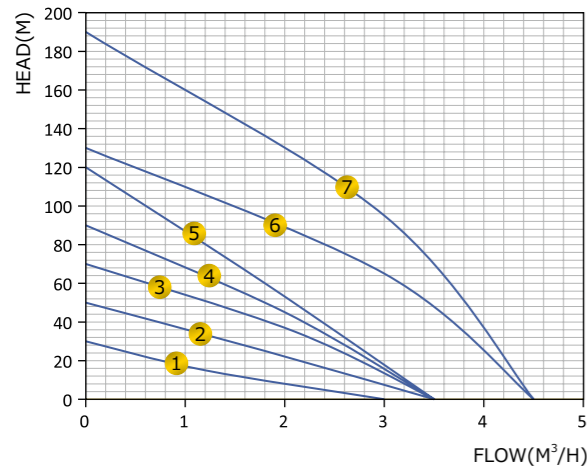

ITEM NO.	ITEM	DC VOLTAGE (V)	BEST INPUT VOLTAGE VOC (V)	POWER (W)	MAX FLOW (M³/H)	MAX HEAD (M)	OUTLET (INCH)
1	4NKC3.0-30-24-300	24	11~55	300	3.0	30	1.25"
2	4NKC3.5-50-48-400	48	45~100	400	3.5	50	1.25"
3	4NKC3.5-70-72-600	72	60~150	600	3.5	70	1.25"
4	4NKC3.5-90-96-750	96	60~200	750	3.5	90	1.25"
5	4NKC3.5-120-144-1100	144	90~340	1100	3.5	120	1.25"
6	4NKC4.5-130-192-1500	192	90~430	1500	4.5	130	1.25"
7	4NKC4.5-190-280-2200	280	100~490	2200	4.5	190	1.25"
8	4NKC6.0-30-48-400	48	45~100	400	6.0	30	1.5"
9	4NKC6.0-40-72-600	72	60~150	600	6.0	40	1.5"
10	4NKC6.5-55-96-750	96	60~200	750	6.5	55	1.5"
11	4NKC6.5-85-144-1100	144	90~340	1100	6.5	85	1.5"
12	4NKC7.0-110-192-1500	192	90~430	1500	7.0	110	1.5"
13	4NKC7.5-150-280-2200	280	100~490	2200	7.5	150	1.5"
14	4NKC7.5-210-385-3000	385	280~780	3000	7.5	210	1.5"
15	4NKC9.0-30-72-600	72	60~150	600	9.0	30	2"
16	4NKC9.0-35-96-750	96	60~200	750	9.0	35	2"
17	4NKC9.0-60-144-1100	144	90~340	1100	9.0	60	2"
18	4NKC10.0-90-192-1500	192	90~430	1500	10.0	90	2"
19	4NKC10.0-130-280-2200	280	100~490	2200	10.0	130	2"
20	4NKC10.0-170-385-3000	385	280~780	3000	10.0	170	2"
21	4NKC13.0-30-96-750	96	60~200	750	13.0	30	2"
22	4NKC14.0-45-144-1100	144	90~340	1100	14.0	45	2"
23	4NKC14.5-70-192-1500	192	90~430	1500	14.5	70	2"
24	4NKC14.5-100-280-2200	280	100~490	2200	14.5	100	2"
25	4NKC14.5-120-385-3000	385	280~780	3000	14.5	120	2"
26	4NKC20.0-45-192-1500	192	90~430	1500	20.0	45	2"
27	4NKC20.0-65-280-2200	280	100~490	2200	20.0	65	2"
28	4NKC20.0-75-385-3000	385	280~780	3000	20.0	75	2"
29	4NKC30.0-35-280-2200	280	100~490	2200	30.0	35	2"
30	4NKC30.0-50-385-3000	385	280~780	3000	30.0	50	2"

## 4" 6" BRUSHLESS SS IMPELLER SOLAR PUMP

### MATERIAL OF PUMP

- ▷ Outlet/connection fitting:304 stainless steel
- ▷ Cylinder:iron
- ▷ Pump body:stainless steel
- ▷ Impeller:304 stainless steel
- ▷ Pump cable:2M
- ▷ Oil cooling
- ▷ MPPT function controller
- ▷ 1 year warranty

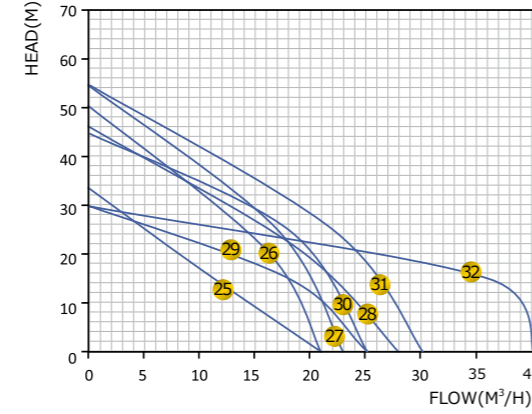
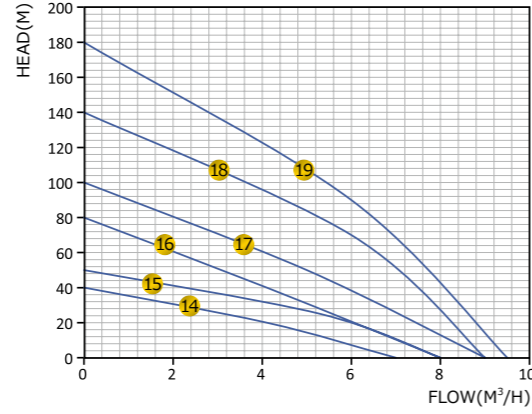
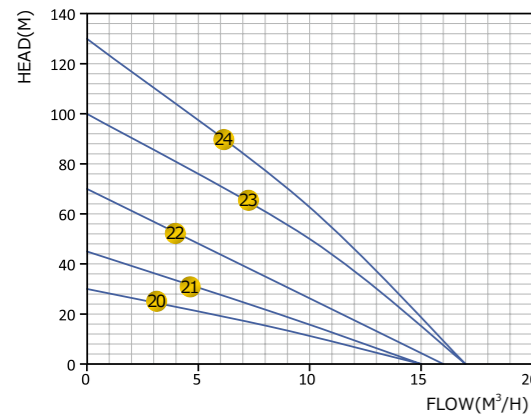
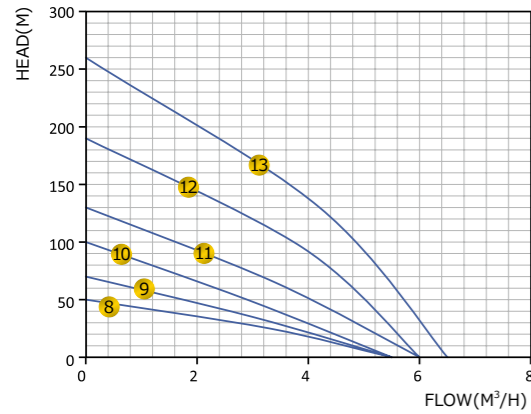
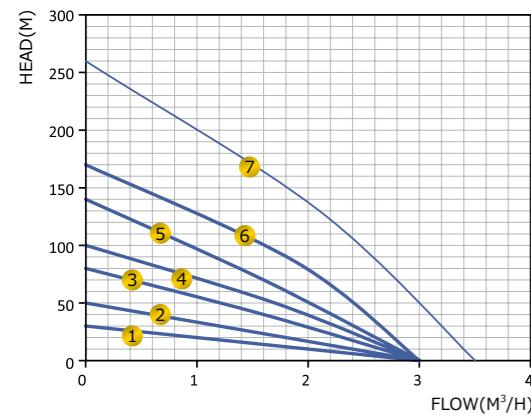
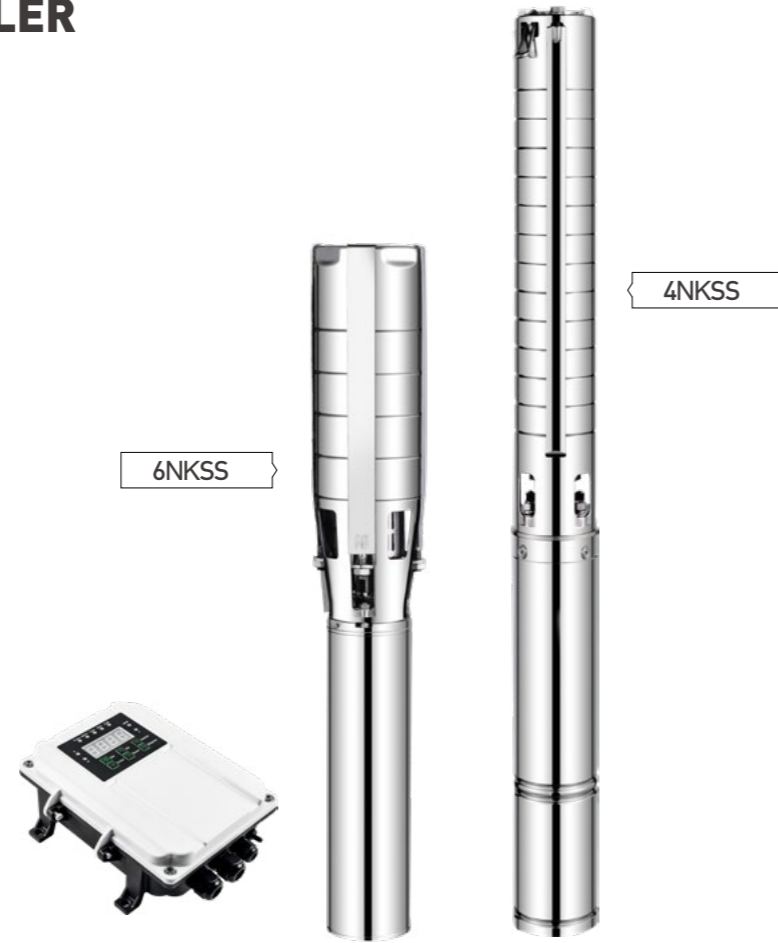

ITEM NO.	ITEM	DC VOLTAGE (V)	BEST INPUT VOLTAGE VOC (V)	POWER (W)	MAX FLOW (M³/H)	MAX HEAD (M)	OUTLET (INCH)
1	4NKSS3.0-30-24-300	24	11~55	300	3.0	30	1.25"
2	4NKSS3.0-50-48-400	48	45~150	400	3.0	50	1.25"
3	4NKSS3.0-80-72-600	72	60~150	600	3.0	80	1.25"
4	4NKSS3.0-100-96-750	96	60~200	750	3.0	100	1.25"
5	4NKSS3.0-140-144-1100	144	90~340	1100	3.0	140	1.25"
6	4NKSS3.0-170-192-1500	192	90~430	1500	3.0	170	1.25"
7	4NKSS3.5-260-280-2200	280	100~490	2200	3.5	260	1.25"
8	4NKSS5.5-50-72-600	72	60~150	600	5.5	50	1.25"
9	4NKSS5.5-70-96-750	96	60~200	750	5.5	70	1.25"
10	4NKSS5.5-100-72-1100	144	90~340	1100	5.5	100	1.25"
11	4NKSS6.0-130-96-1500	192	90~430	1500	6.0	130	1.25"
12	4NKSS6.0-190-280-2200	280	100~490	2200	6.0	190	1.25"
13	4NKSS6.5-260-385-3000	385	280~780	3000	6.5	260	1.25"
14	4NKSS7.0-40-72-600	72	60~150	600	7.0	40	1.5"
15	4NKSS8.0-50-96-750	96	60~200	750	8.0	50	1.5"
16	4NKSS8.0-80-144-1100	144	90~340	1100	8.0	80	1.5"
17	4NKSS9.0-100-192-1500	192	90~430	1500	9.0	100	1.5"
18	4NKSS9.0-140-280-2200	280	100~490	2200	9.0	140	1.5"
19	4NKSS9.5-180-385-3000	385	280~780	3000	9.5	180	1.5"
20	4NKSS15.0-30-96-750	96	60~200	750	15.0	30	2"
21	4NKSS15.0-45-144-1100	144	90~340	1100	15.0	45	2"
22	4NKSS16.0-70-192-1500	192	90~430	1500	16.0	70	2"
23	4NKSS17.0-100-280-2200	280	100~490	2200	17.0	100	2"
24	4NKSS17.0-130-385-3000	385	280~780	3000	17.0	130	2"
25	4NKSS21.0-35-192-1500	192	90~430	1500	21.0	35	2"
26	4NKSS23.0-55-280-2200	280	100~490	2200	23.0	55	2"
27	4NKSS23.0-65-385-3000	385	280~780	3000	23.0	65	2"
28	4NKSS28.0-55-385-3000	385	280~780	3000	28.0	55	2"
29	6NKSS25.0-30-192-1500	192	90~430	1500	25.0	30	3"
30	6NKSS25.0-45-280-2200	280	100~490	2200	25.0	45	3"
31	6NKSS30.0-55-385-3000	385	280~780	3000	30.0	55	3"
32	6NKSS40.0-30-385-3000	385	280~780	3000	40.0	30	3"

## NKQB DC SOLAR SURFACE PUMP

### MATERIAL OF PUMP

- ▷ Outlet:iron/stainless steel
- ▷ Pump head:iron/stainless steel
- ▷ Pump body:aluminium
- ▷ Impeller:brass
- ▷ Pump cable:1.2M
- ▷ MPPT function controller
- ▷ 1 year warranty

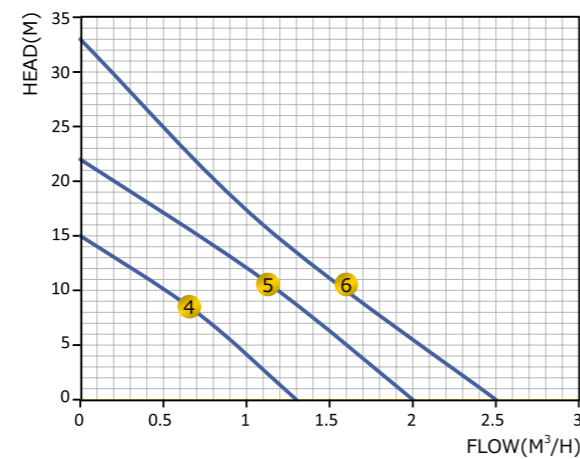
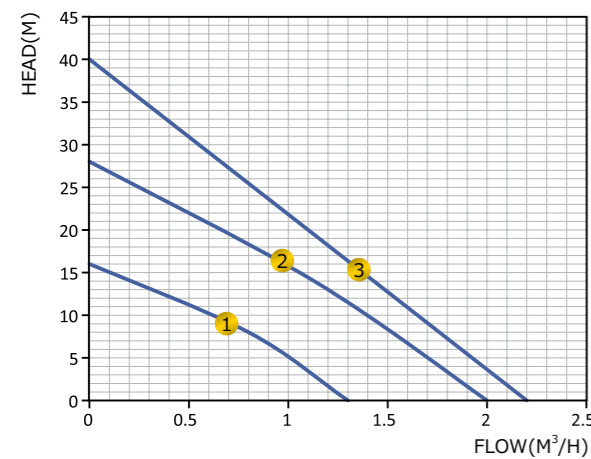

ITEM NO.	DC VOLTAGE (V)	BEST INPUT VOLTAGE VOC (V)	POWER (W)	MAX FLOW (M³/H)	MAX HEAD (M)	MAX SUCT (M)	OUTLET (INCH)
1 NKQB1.3-16-12-150	12	11~55	150	1.3	16	8	1.0"×1.0"
2 NKQB2.0-28-24-250	24	11~55	250	2.0	28	8	1.0"×1.0"
3 NKQB2.2-40-48-400	48	45~100	400	2.2	40	8	1.0"×1.0"
4 NKQB1.3-15-12-150-S	12	11~55	150	1.3	15	8	1.0"×1.0"
5 NKQB2.0-22-24-250-S	24	11~55	250	2.0	22	8	1.0"×1.0"
6 NKQB2.5-33-48-400-S	48	45~100	400	2.5	33	8	1.0"×1.0"

## NKGJ / PSZ DC SOLAR SURFACE PUMP

### MATERIAL OF PUMP

- ▷ Outlet:stainless steel/Iron
- ▷ Pump head:stainless steel/Iron
- ▷ Pump body:aluminium
- ▷ Impeller:brass/Iron
- ▷ Pump cable:1.2M
- ▷ MPPT function controller
- ▷ 1 year warranty

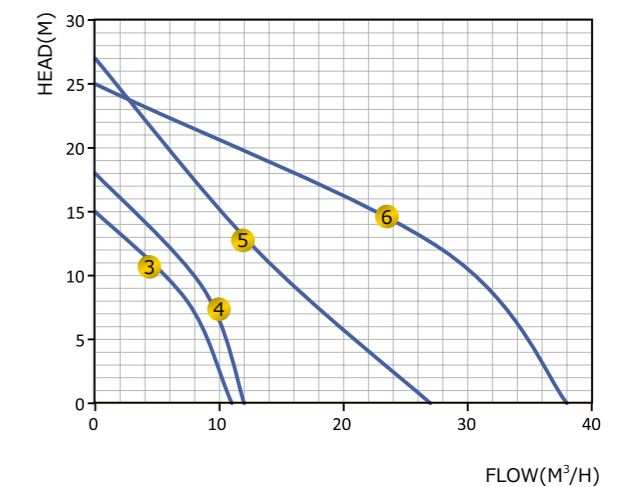
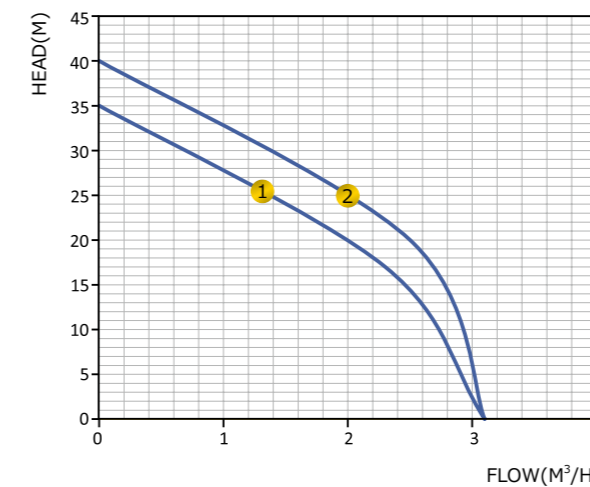

ITEM NO.	DC VOLTAGE (V)	BEST INPUT VOLTAGE VOC (V)	POWER (W)	MAX FLOW (M³/H)	MAX HEAD (M)	MAX SUCT (M)	OUTLET (INCH)
1 NKGJ3.1-35-72-600	72	60~150	600	3.1	35	8	1.0"×1.0"
2 NKGJ3.1-40-96-750	96	60~200	750	3.1	40	8	1.0"×1.0"
3 NKZ11-15-72-600	72	60~150	600	11	15	8	1.5"×1.5"(PIPE)
4 NKZ12-18-96-750	96	60~200	750	12	18	8	2.0"×2.0"(PIPE)
5 NKZ16-27-192-1500	192	90~430	1500	16	27	8	2.0"×2.0"
6 NKZ38-25-280-2200	280	100~490	2200	38	25	8	3.0"×3.0"

## NKHF DC SOLAR SURFACE PUMP

### MATERIAL OF PUMP

- ▷ Outlet:iron
- ▷ Pump head:iron
- ▷ Pump body:aluminium
- ▷ Impeller:brass
- ▷ Pump cable:1.2M
- ▷ MPPT function controller
- ▷ 1 year warranty

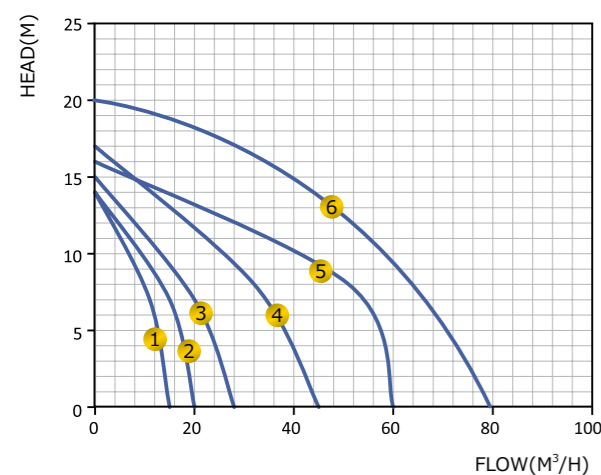

ITEM NO.	DC VOLTAGE (V)	BEST INPUT VOLTAGE VOC (V)	POWER (W)	MAX FLOW (M <sup>3</sup> /H)	MAX HEAD (M)	MAX SUCT (M)	OUTLET (INCH)
1 NKHF15-14-72-600	72	60~150	600	15	14	8	1.5"×1.5"
2 NKHF20-14-96-750	96	60~200	750	20	14	8	2.0"×2.0"
3 NKHF28-15-144-1100	144	90~340	1100	28	15	8	2.0"×2.0"
4 NKHF45-17-192-1500	192	90~430	1500	45	17	8	3.0"×3.0"
5 NKHF60-16-280-2200	280	100~490	2200	60	16	8	4.0"×4.0"
6 NKHF80-20-385-3000	385	280~780	3000	80	20	8	5.0"×5.0"

## NKSU DC SOLAR SURFACE PUMP

### MATERIAL OF PUMP

- ▷ Outlet:aluminium
- ▷ Pump head:aluminium
- ▷ Pump body:aluminium
- ▷ Impeller:iron
- ▷ Pump cable:1.2M
- ▷ MPPT function controller
- ▷ 1 year warranty

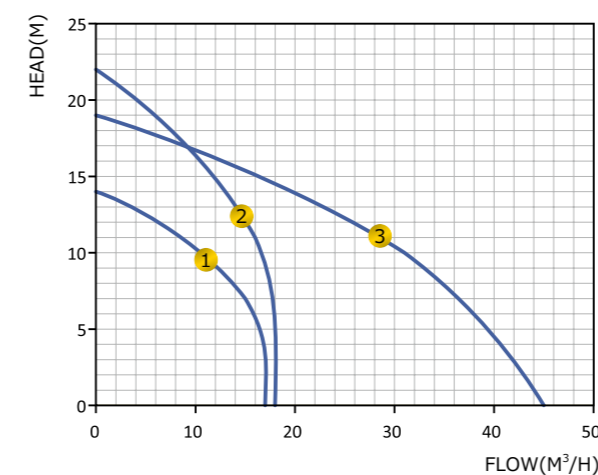

ITEM NO.	DC VOLTAGE (V)	BEST INPUT VOLTAGE VOC (V)	POWER (W)	MAX FLOW (M <sup>3</sup> /H)	MAX HEAD (M)	MAX SUCT (M)	OUTLET (INCH)
1 NKSU17-14-144-1100	144	90~340	1100	17	14	8	2.0"×2.0"
2 NKSU18-22-192-1500	192	90~430	1500	18	22	8	2.0"×2.0"
3 NKSU45-19-280-2200	280	100~490	2200	45	19	8	3.0"×3.0"

## NKP DC SOLAR SWIMMING POOL PUMP

### MATERIAL OF PUMP

- ▷ Outlet:plastic
- ▷ Pump head:plastic
- ▷ Pump body:aluminium
- ▷ Impeller:plastic
- ▷ Pump cable:1.2M
- ▷ MPPT function controller
- ▷ 1 year warranty

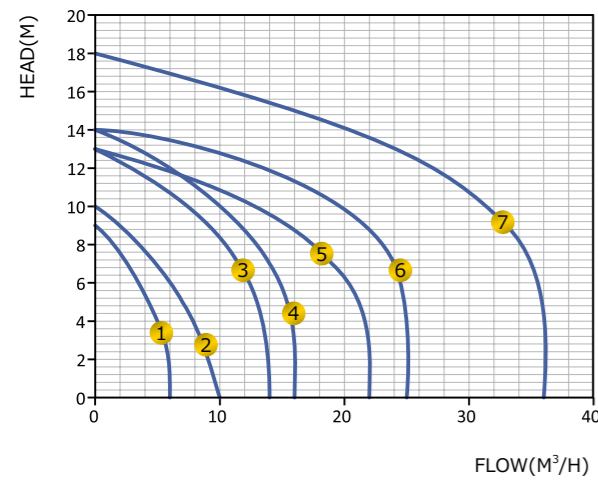

ITEM NO.	DC VOLTAGE (V)	BEST INPUT VOLTAGE VOC (V)	POWER (W)	MAX FLOW (M³/H)	MAX HEAD (M)	MAX SUCT (M)	TUBE DIAMETER (MM)
1 NKP6-9-24-200	24	11~55	200	6	9	8	Φ 32/ Φ 38
2 NKP10-10-24-370	24	11~55	370	10	10	8	Φ 50
3 NKP14-13-72-600	72	60~150	600	14	13	8	Φ 50
4 NKP16-14-96-750	96	60~200	750	16	14	8	Φ 50
5 NKP22-13-144-1100	144	90~340	1100	22	13	8	Φ 60/ Φ 63
6 NKP25-14-192-1500	192	90~430	1500	25	14	8	Φ 60/ Φ 63
7 NKP36-18-280-2200	280	100~490	2200	36	18	8	Φ 60/ Φ 63

## NKG DC SOLAR SUBMERSIBLE PUMP

### MATERIAL OF PUMP

- ▷ Outlet:iron
- ▷ Pump head:iron
- ▷ Pump body:iron
- ▷ Impeller:aluminium
- ▷ Pump cable:2M
- ▷ MPPT function controller
- ▷ 1 year warranty

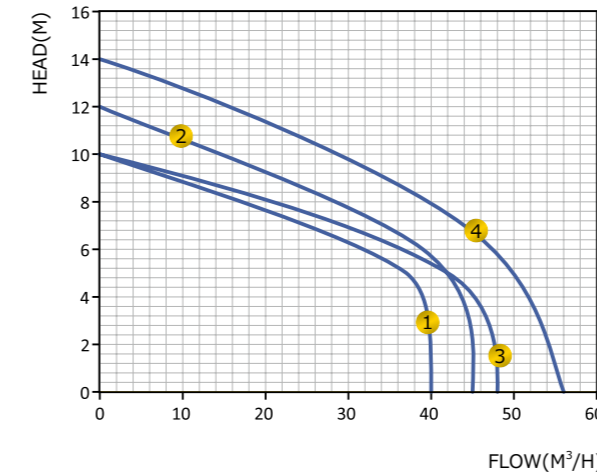

ITEM NO.	DC VOLTAGE (V)	BEST INPUT VOLTAGE VOC (V)	POWER (W)	MAX FLOW (M³/H)	MAX HEAD (M)	OUTLET (INCH)
1 NKG40-10-144-1100	144	90~340	1100	40	10	3"
2 NKG45-12-192-1500	192	90~430	1500	45	12	3"
3 NKG48-10-192-1500	192	90~430	1500	48	10	4"
4 NKG56-14-280-2200	280	100~490	2200	56	14	4"

## 2. AC/DC SOLAR PUMP

- ▷ Support single phase 220V AC 50/60Hz (90-240Vac) electricity/generator input and solar DC power input, can realize AC or DC input switching by operating a external knife switch.
- ▷ Permanent magnet DC brushless motor, efficiency improved by 20~30%.
- ▷ Longer service life than normal electrical AC pump motor.
- ▷ High efficiency intelligent MPPT controller makes pump start and stop working automatically.
- ▷ Overload protection, over current protection, underload protection, under voltage protection, reverse connect protection, thermal protection, well shortage water protection, soft start.
- ▷ Controller LED screen displays voltage, current, power, speed RPM, adjusting speed, error code.
- ▷ Controller waterproofing grade IP54.
- ▷ Ambient temperature: -15~70 °C.

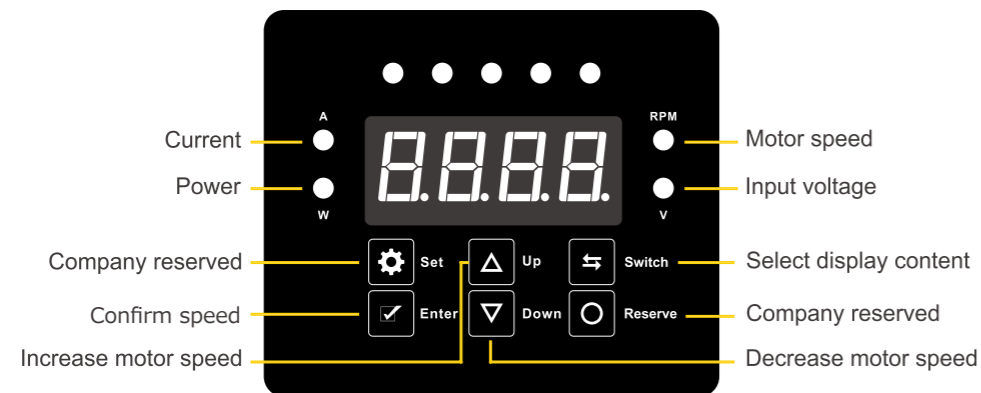

## AC input and DC input can work at the same time

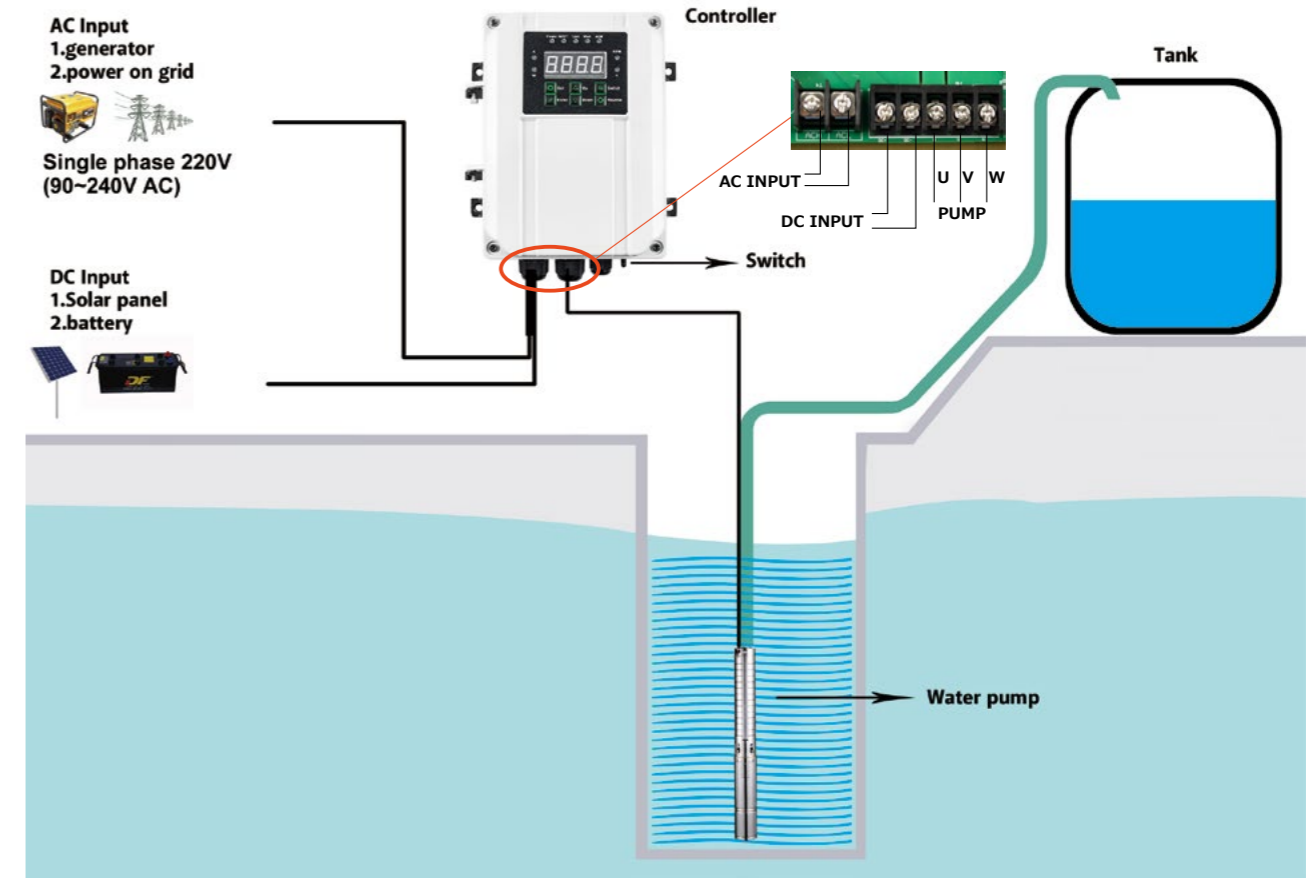

## Solar panels connection for AC/DC solar pump

AC/DC Pump	AC Input Voltage(V)	DC Input Voltage VOC(V)	Solar Panels Connection
72V 600W	Single phase 220 (90~240)	60~200	 250Wp*4PCS 300Wp*3PCS
96V 750W	Single phase 220 (90~240)	60~240	 250Wp*4PCS 300Wp*4PCS
144V 1100W	Single phase 220 (90~240)	90~340	 250Wp*6PCS 300Wp*5PCS
192V 1500W	Single phase 220 (90~240)	90~430	 250Wp*8PCS 300Wp*7PCS
280V 2200W	Single phase 220 (90~240)	100~490	 250Wp*12PCS 300Wp*10PCS

## 3" AC/DC PLASTIC IMPELLER SOLAR PUMP

### MATERIAL OF PUMP

- ▷ Outlet/connection fitting: stainless steel
- ▷ Cylinder: iron
- ▷ Pump body: 201 stainless steel
- ▷ Pump cable: 2M
- ▷ Oil cooling
- ▷ MPPT function controller
- ▷ 1 year warranty

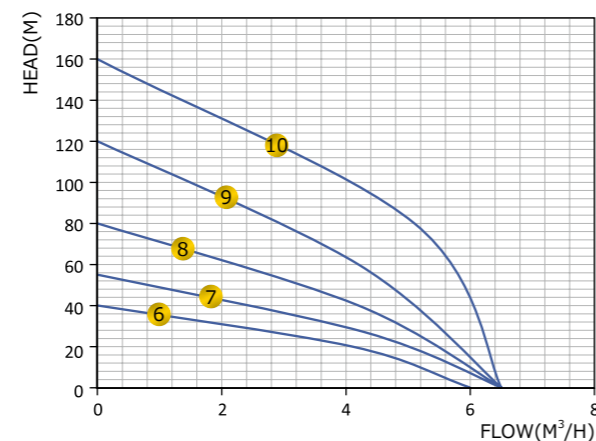
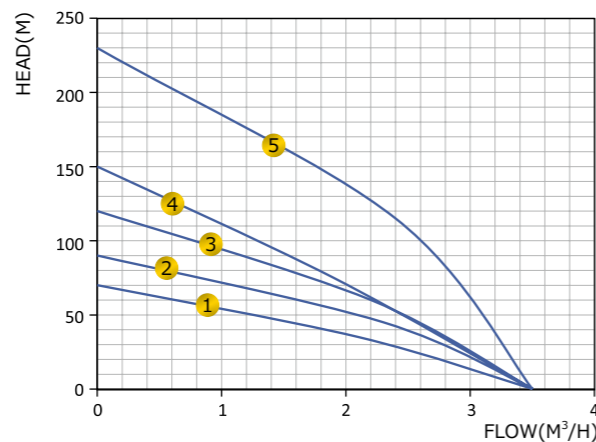

ITEM NO.	ITEM	AC INPUT VOLTAGE (V)	DC INPUT VOLTAGE VOC (V)	POWER (W)	MAX FLOW (M³/H)	MAX HEAD (M)	OUTLET (INCH)
1	3NKC3.5-70-72-600-H	90~240	60~200	600	3.5	70	1"
2	3NKC3.5-90-96-750-H	90~240	60~240	750	3.5	90	1"
3	3NKC3.5-120-144-1100-H	90~240	90~340	1100	3.5	120	1"
4	3NKC3.5-150-192-1500-H	90~240	90~430	1500	3.5	150	1"
5	3NKC3.5-230-280-2200-H	90~240	100~490	2200	3.5	230	1"
6	3NKC6.0-40-72-600-H	90~240	60~200	600	6.0	40	1"
7	3NKC6.5-55-96-750-H	90~240	60~240	750	6.5	55	1"
8	3NKC6.5-80-144-1100-H	90~240	90~340	1100	6.5	80	1"
9	3NKC6.5-120-192-1500-H	90~240	90~430	1500	6.5	120	1"
10	3NKC6.5-160-280-2200-H	90~240	100~490	2200	6.5	160	1"

## 3" AC/DC SS IMPELLER SOLAR PUMP

### MATERIAL OF PUMP

- ▷ Outlet/connection fitting: 304 stainless steel
- ▷ Cylinder: iron
- ▷ Pump body: stainless steel
- ▷ Impeller: 304 stainless steel
- ▷ Pump cable: 2M
- ▷ Oil cooling
- ▷ MPPT function controller
- ▷ 1 year warranty

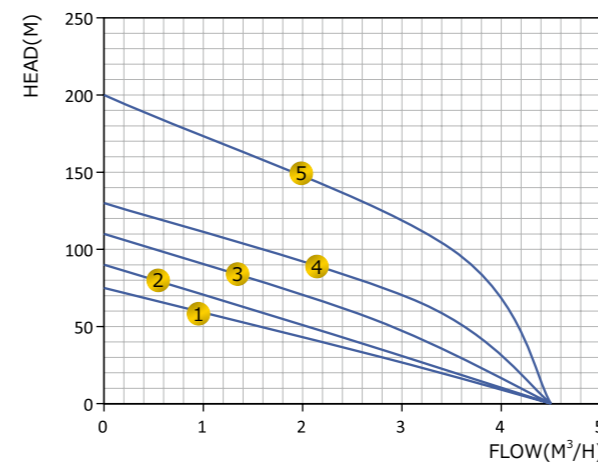
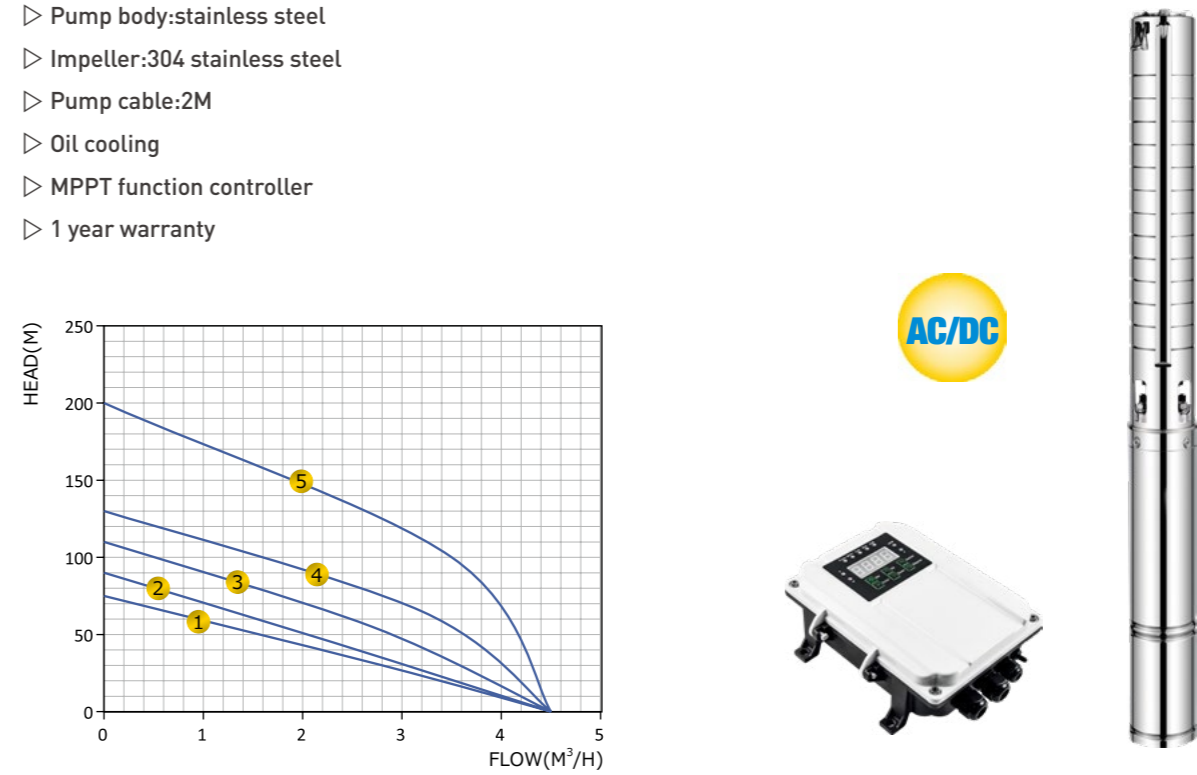

ITEM NO.	ITEM	AC INPUT VOLTAGE (V)	DC INPUT VOLTAGE VOC (V)	POWER (W)	MAX FLOW (M³/H)	MAX HEAD (M)	OUTLET (INCH)
1	3PNKS4.5-75-72-600-H	90~240	60~200	600	4.5	75	1.25"
2	3PNKS4.5-90-96-750-H	90~240	60~240	750	4.5	90	1.25"
3	3PNKS4.5-110-144-1100-H	90~240	90~340	1100	4.5	110	1.25"
4	3PNKS4.5-130-192-1500-H	90~240	90~430	1500	4.5	130	1.25"
5	3PNKS4.5-200-280-2200-H	90~240	100~490	2200	4.5	200	1.25"

## 4" AC/DC PLASTIC IMPELLER SOLAR PUMP

### MATERIAL OF PUMP

- ▷ Outlet/connection fitting:stainless steel
- ▷ Cylinder:iron
- ▷ Pump body:stainless steel
- ▷ Impeller:plastic impeller
- ▷ Pump cable:2M
- ▷ Oil cooling
- ▷ MPPT function controller
- ▷ 1 year warranty

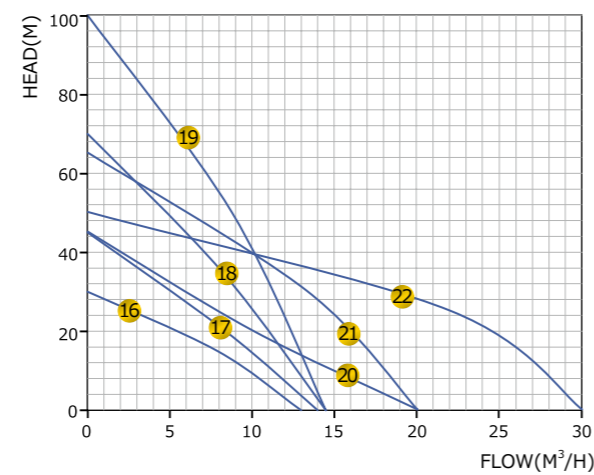
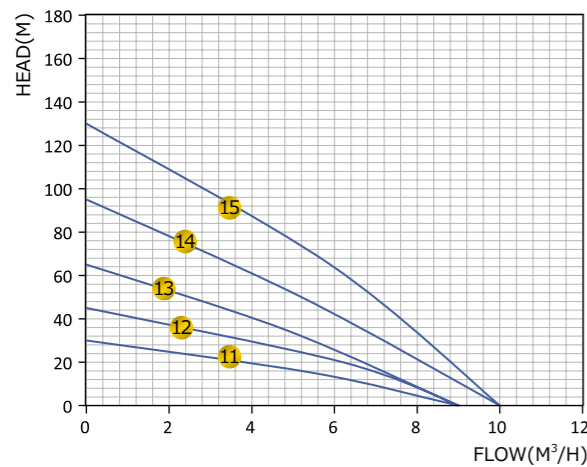
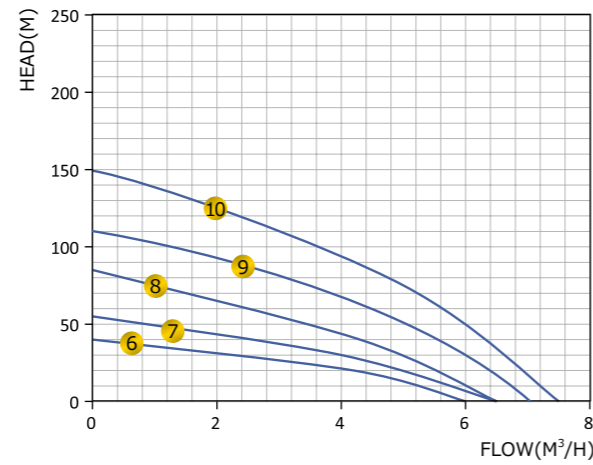
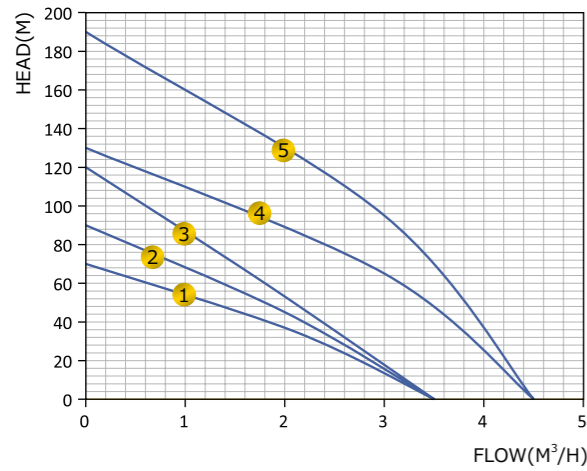

ITEM NO.	MODEL	AC INPUT VOLTAGE (V)	DC INPUT VOLTAGE VOC (V)	POWER (W)	MAX FLOW (M³/H)	MAX HEAD (M)	OUTLET (INCH)
1	4NKC3.5-70-72-600-H	90~240	60~200	600	3.5	70	1.25"
2	4NKC3.5-90-96-750-H	90~240	60~240	750	3.5	90	1.25"
3	4NKC3.5-120-144-1100-H	90~240	90~340	1100	3.5	120	1.25"
4	4NKC4.5-130-192-1500-H	90~240	90~430	1500	4.5	130	1.25"
5	4NKC4.5-190-280-2200-H	90~240	100~490	2200	4.5	190	1.25"
6	4NKC6.0-40-72-600-H	90~240	60~200	600	6.0	40	1.5"
7	4NKC6.5-55-96-750-H	90~240	60~240	750	6.5	55	1.5"
8	4NKC6.5-85-144-1100-H	90~240	90~340	1100	6.5	85	1.5"
9	4NKC7.0-110-192-1500-H	90~240	90~430	1500	7.0	110	1.5"
10	4NKC7.5-150-280-2200-H	90~240	100~490	2200	7.5	150	1.5"
11	4NKC9.0-30-72-600-H	90~240	60~200	600	9.0	30	2"
12	4NKC9.0-35-96-750-H	90~240	60~240	750	9.0	35	2"
13	4NKC9.0-60-144-1100-H	90~240	90~340	1100	9.0	60	2"
14	4NKC10.0-90-192-1500-H	90~240	90~430	1500	10.0	90	2"
15	4NKC10.0-130-280-2200-H	90~240	100~490	2200	10.0	130	2"
16	4NKC13.0-30-96-750-H	90~240	60~200	750	13.0	30	2"
17	4NKC14.0-45-144-1100-H	90~240	90~340	1100	14.0	45	2"
18	4NKC14.5-70-192-1500-H	90~240	90~430	1500	14.5	70	2"
19	4NKC14.5-100-280-2200-H	90~240	100~490	2200	14.5	100	2"
20	4NKC20.0-45-192-1500-H	90~240	90~430	1500	20.0	45	2"
21	4NKC20.0-65-280-2200-H	90~240	100~490	2200	20.0	65	2"
22	4NKC30.0-35-280-2200-H	90~240	100~490	2200	30.0	35	2"

## 4" 6" AC/DC SS IMPELLER SOLAR PUMP

### MATERIAL OF PUMP

- ▷ Outlet/connection fitting:304 stainless steel
- ▷ Cylinder:iron
- ▷ Pump body:stainless steel
- ▷ Impeller:304 stainless steel
- ▷ Pump cable:2M
- ▷ Oil cooling
- ▷ MPPT function controller
- ▷ 1 year warranty



6PNKS -H

4PNKS-H

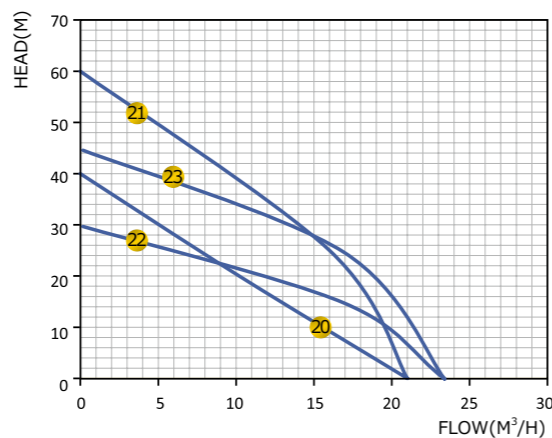
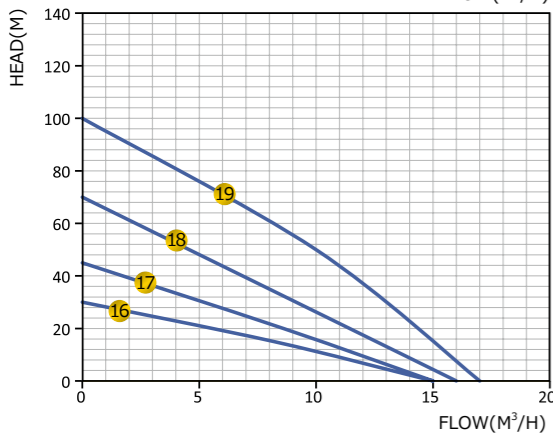
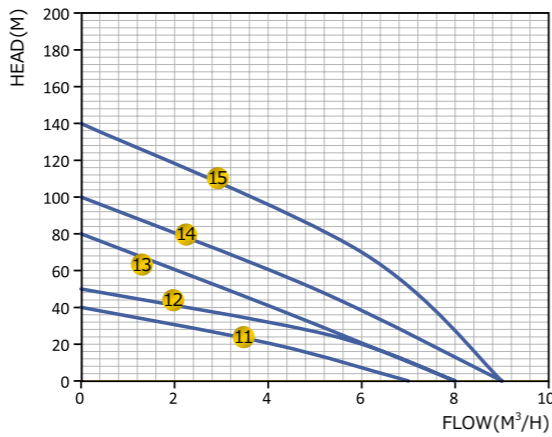
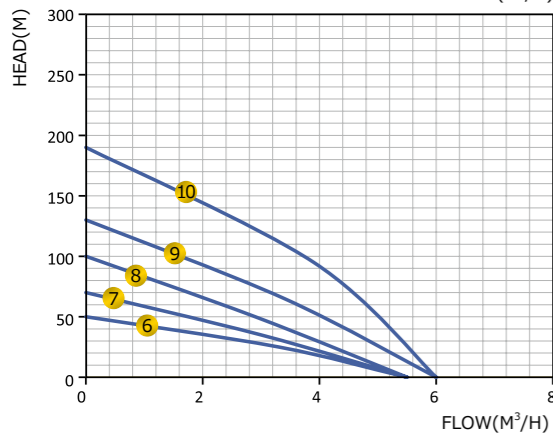
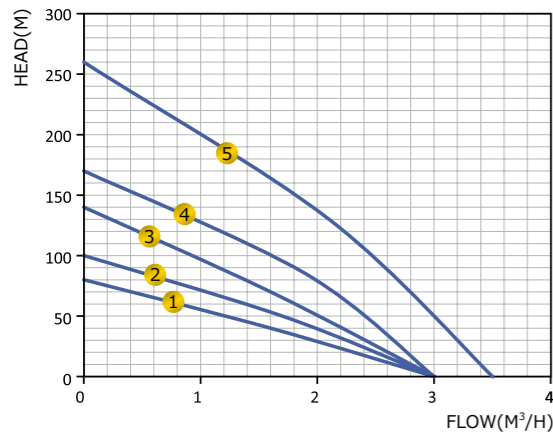

ITEM NO.	ITEM	AC INPUT VOLTAGE (V)	DC INPUT VOLTAGE VOC (V)	POWER (W)	MAX FLOW (M³/H)	MAX HEAD (M)	OUTLET (INCH)
1	4PNKS3.0-80-72-600-H	90~240	60~200	600	3.0	80	1.25"
2	4PNKS3.0-100-96-750-H	90~240	60~240	750	3.0	100	1.25"
3	4PNKS3.0-140-144-1100-H	90~240	90~340	1100	3.0	140	1.25"
4	4PNKS3.0-170-192-1500-H	90~240	90~430	1500	3.0	170	1.25"
5	4PNKS3.5-260-280-2200-H	90~240	100~490	2200	3.5	260	1.25"
6	4PNKS5.5-50-72-600-H	90~240	60~200	600	5.5	50	1.25"
7	4PNKS5.5-70-96-750-H	90~240	60~240	750	5.5	70	1.25"
8	4PNKS5.5-100-144-1100-H	90~240	90~340	1100	5.5	100	1.25"
9	4PNKS6.0-130-192-1500-H	90~240	90~430	1500	6.0	130	1.25"
10	4PNKS6.0-190-280-2200-H	90~240	100~490	2200	6.0	190	1.25"
11	4PNKS7.0-40-72-600-H	90~240	60~200	600	7.0	40	1.5"
12	4PNKS8.0-50-96-750-H	90~240	60~240	750	8.0	50	1.5"
13	4PNKS8.0-80-144-1100-H	90~240	90~340	1100	8.0	80	1.5"
14	4PNKS9.0-100-192-1500-H	90~240	90~430	1500	9.0	100	1.5"
15	4PNKS9.0-140-280-2200-H	90~240	100~490	2200	9.0	140	1.5"
16	4PNKS15.0-30-96-750-H	90~240	60~240	750	15.0	30	2"
17	4PNKS15.0-45-144-1100-H	90~240	90~340	1100	15.0	45	2"
18	4PNKS16.0-70-192-1500-H	90~240	90~430	1500	16.0	70	2"
19	4PNKS17.0-100-280-2200-H	90~240	100~490	2200	17.0	100	2"
20	4PNKS21.0-40-192-1500-H	90~240	90~430	1500	21.0	40	2"
21	4PNKS21.0-60-280-2200-H	90~240	100~490	2200	21.0	60	2"
22	6PNKS25.0-30-192-1500-H	90~240	90~430	1500	25.0	30	3"
23	6PNKS25.0-45-280-2200-H	90~240	100~490	2200	25.0	45	3"

## NKGJ-H / PZSU-H AC/DC SOLAR SURFACE PUMP

### MATERIAL OF PUMP

- ▷ Outlet:stainless steel/aluminium
- ▷ Pump head:stainless steel/aluminium
- ▷ Pump body:aluminium
- ▷ Impeller:brass/iron
- ▷ Cable:1.2M
- ▷ Air cooling
- ▷ MPPT function controller
- ▷ AC input:single phase 220V
- ▷ 1 year warranty

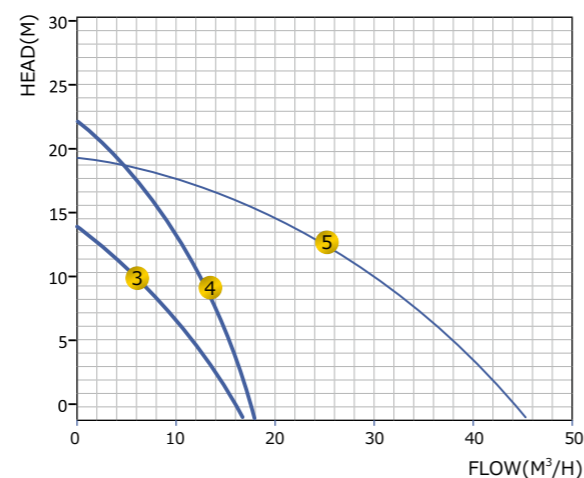
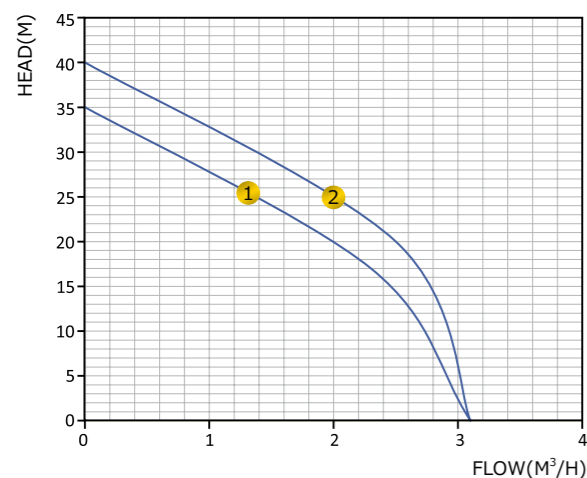

ITEM NO.	ITEM	AC INPUT VOLTAGE (V)	DC INPUT VOLTAGE VOC (V)	POWER (W)	MAX FLOW (M³/H)	MAX HEAD (M)	MAX SUCT (M)	OUTLET (INCH)
1	NKGJ3.1-35-72-600-H	90~240	60~200	600	3.1	35	8	1.0"×1.0"
2	NKGJ3.1-40-96-750-H	90~240	60~240	750	3.1	40	8	1.0"×1.0"
3	NKSU17-14-144-1100-H	90~240	90~340	1100	17	14	8	2.0"×2.0"
4	NKSU18-22-192-1500-H	90~240	90~430	1500	18	22	8	2.0"×2.0"
5	NKSU45-19-280-2200-H	90~240	100~490	2200	45	19	8	3.0"×3.0"

## NKPHF-H AC/DC SOLAR SURFACE PUMP

### MATERIAL OF PUMP

- ▷ Outlet:iron
- ▷ Pump head:iron
- ▷ Pump body:aluminium
- ▷ Impeller:brass
- ▷ Pump cable:1.2M
- ▷ MPPT function controller
- ▷ 1 year warranty

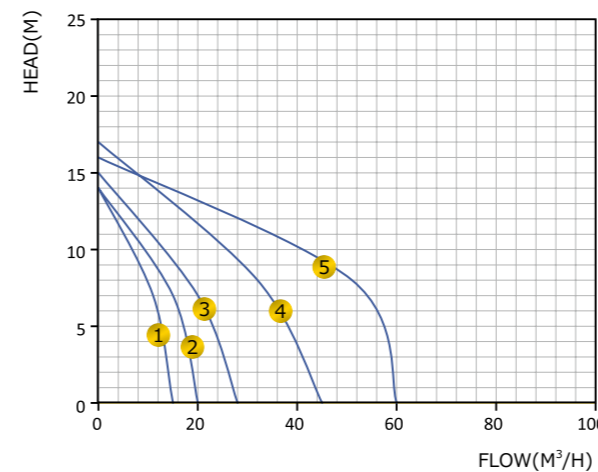

ITEM NO.	ITEM	AC INPUT VOLTAGE (V)	DC INPUT VOLTAGE VOC (V)	POWER (W)	MAX FLOW (M³/H)	MAX HEAD (M)	MAX SUCT (M)	OUTLET (INCH)
1	NKPHF15-14-72-600-H	90~240	60~200	600	15	14	8	1.5"×1.5"
2	NKPHF20-14-96-750-H	90~240	60~240	750	20	14	8	2.0"×2.0"
3	NKPHF28-15-144-1100-H	90~240	90~340	1100	28	15	8	2.0"×2.0"
4	NKPHF45-17-192-1500-H	90~240	90~430	1500	45	17	8	3.0"×3.0"
5	NKPHF60-16-280-2200-H	90~240	100~490	2200	60	16	8	4.0"×4.0"

## NKP-H AC/DC SOLAR SWIMMING POOL PUMP

### MATERIAL OF PUMP

- ▷ Outlet:plastic
- ▷ Pump head:plastic
- ▷ Pump body:aluminium
- ▷ Impeller:plastic
- ▷ Pump cable:1.2M
- ▷ MPPT function controller
- ▷ 1 year warranty

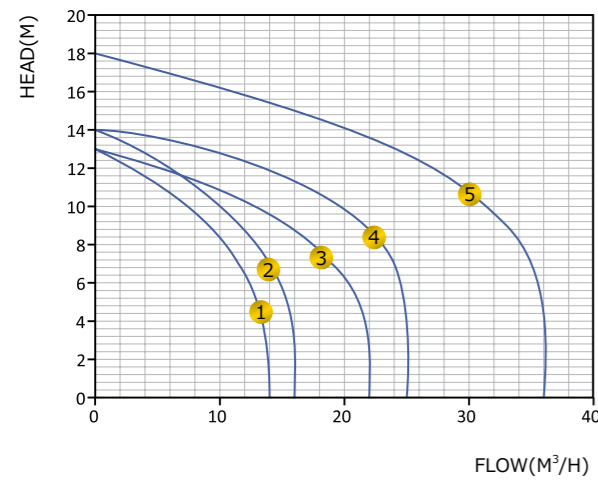

ITEM NO.	ITEM	AC INPUT VOLTAGE (V)	DC INPUT VOLTAGE VOC (V)	POWER (W)	MAX FLOW (M <sup>3</sup> /H)	MAX HEAD (M)	MAX SUCT (M)	TUBE DIAMETER (MM)
1	NKP14-13-72-600-H	90~240	60~200	600	14	13	8	Φ 50
2	NKP16-14-96-750-H	90~240	60~240	750	16	14	8	Φ 50
3	NKP22-13-144-1100-H	90~240	90~340	1100	22	13	8	Φ 60/ Φ 63
4	NKP25-14-192-1500-H	90~240	90~430	1500	25	14	8	Φ 60/ Φ 63
5	NKP36-18-280-2200-H	90~240	100~490	2200	36	18	8	Φ 60/ Φ 63

## NKG-H AC/DC SOLAR SUBMERSIBLE PUMP

### MATERIAL OF PUMP

- ▷ Outlet:iron
- ▷ Pump head:iron
- ▷ Pump body:iron
- ▷ Impeller:aluminium
- ▷ Pump cable:2M
- ▷ MPPT function controller
- ▷ 1 year warranty

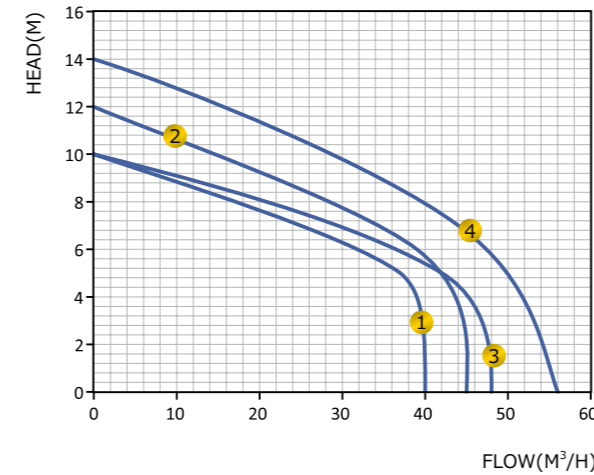

ITEM NO.	ITEM	AC INPUT VOLTAGE (V)	DC INPUT VOLTAGE VOC (V)	POWER (W)	MAX FLOW (M <sup>3</sup> /H)	MAX HEAD (M)	OUTLET (INCH)
1	NKG40-10-144-1100-H	90~240	90~340	1100	40	10	3"
2	NKG45-12-192-1500-H	90~240	90~430	1500	45	12	3"
3	NKG48-10-192-1500-H	90~240	90~430	1500	48	10	4"
4	NKG56-14-280-2200-H	90~240	100~490	2200	56	14	4"